

## 74LVQ244 Low Voltage Octal Buffer/Line Driver with 3-STATE Outputs

### General Description

The LVQ244 is an octal buffer and line driver designed to be employed as a memory address driver, clock driver and bus oriented transmitter or receiver which provides improved PC board density.

### Features

- Ideal for low power/low noise 3.3V applications
- Implements patented EMI reduction circuitry
- Available in SOIC JEDEC, SOIC EIAJ and QSOP packages
- Guaranteed simultaneous switching noise level and dynamic threshold performance
- Improved latch-up immunity
- Guaranteed incident wave switching into 75Ω
- 4 kV minimum ESD immunity

### Ordering Code:

Order Number	Package Number	Package Description
74LVQ244SC	M20B	20-Lead (0.300" Wide) Molded Small Outline Package, SOIC, JEDEC
74LVQ244SJ	M20D	20-Lead Shrink Molded Small Outline Package, SOIC, EIAJ
74LVQ244QSC	MQA20	20-Lead (0.150" Wide) Molded Shrink Small Outline Package, SSOP, JEDEC

Device also available in Tape and Reel. Specify by appending suffix letter "X" to the ordering code.

### Logic Symbol

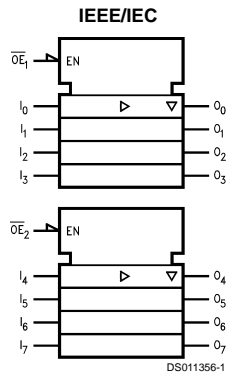

### Connection Diagram

Pin Assignment for SOIC and QSOP

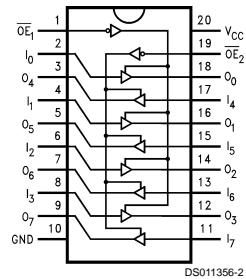

## Truth Tables

Inputs		Outputs (Pins 12, 14, 16, 18)
$\overline{OE}_1$	$I_n$	
L	L	L
L	H	H
H	X	Z

Inputs		Outputs (Pins 3, 5, 7, 9)
$\overline{OE}_2$	$I_n$	
L	L	L
L	H	H
H	X	Z

H = HIGH Voltage Level  
 L = LOW Voltage Level  
 X = Immaterial  
 Z = High Impedance

## Pin Descriptions

Pin Names	Description
$\overline{OE}_1, \overline{OE}_2$	3-STATE Output Enable Inputs
$I_0-I_7$	Inputs
$O_0-O_7$	Outputs

## Absolute Maximum Ratings (Note 1)

Supply Voltage ( $V_{CC}$ )	-0.5V to +7.0V
DC Input Diode Current ( $I_{IK}$ )	
$V_I = -0.5V$	-20 mA
$V_I = V_{CC} + 0.5V$	+20 mA
DC Input Voltage ( $V_I$ )	-0.5V to $V_{CC} + 0.5V$
DC Output Diode Current ( $I_{OK}$ )	
$V_O = -0.5V$	-20 mA
$V_O = V_{CC} + 0.5V$	+20 mA
DC Output Voltage ( $V_O$ )	-0.5V to $V_{CC} + 0.5V$
DC Output Source or Sink Current ( $I_O$ )	$\pm 50$ mA
DC $V_{CC}$ or Ground Current ( $I_{CC}$ or $I_{GND}$ )	$\pm 400$ mA
Storage Temperature ( $T_{STG}$ )	-65°C to +150°C
DC Latch-Up Source or Sink Current	$\pm 300$ mA

## Recommended Operating Conditions (Note 2)

Supply Voltage ( $V_{CC}$ )	2.0V to 3.6V
Input Voltage ( $V_I$ )	0V to $V_{CC}$
Output Voltage ( $V_O$ )	0V to $V_{CC}$
Operating Temperature ( $T_A$ )	-40°C to +85°C
Minimum Input Edge Rate $\Delta V/\Delta t$	
$V_{IN}$ from 0.8V to 2.0V	
$V_{CC}$ @ 3.0V	125 mV/ns

**Note 1:** The "Absolute Maximum Ratings" are those values beyond which the safety of the device cannot be guaranteed. The device should not be operated at these limits. The parametric values defined in the Electrical Characteristics tables are not guaranteed at the absolute maximum ratings. The "Recommended Operating Conditions" table will define the conditions for actual device operation.

**Note 2:** Unused inputs must be held HIGH or LOW. They may not float.

## DC Electrical Characteristics

Symbol	Parameter	$V_{CC}$ (V)	$T_A = +25^\circ C$		$T_A = -40^\circ C$ to $+85^\circ C$	Units	Conditions
			Typ	Guaranteed Limits			
$V_{IH}$	Minimum High Level Input Voltage	3.0	1.5	2.0	2.0	V	$V_{OUT} = 0.1V$ or $V_{CC} - 0.1V$
$V_{IL}$	Maximum Low Level Input Voltage	3.0	1.5	0.8	0.8	V	$V_{OUT} = 0.1V$ or $V_{CC} - 0.1V$
$V_{OH}$	Minimum High Level Output Voltage	3.0	2.99	2.9	2.9	V	$I_{OUT} = -50 \mu A$
		3.0		2.58	2.48	V	$V_{IN} = V_{IL}$ or $V_{IH}$ (Note 3) $I_{OH} = -12$ mA
$V_{OL}$	Maximum Low Level Output Voltage	3.0	0.002	0.1	0.1	V	$I_{OUT} = 50 \mu A$
		3.0		0.36	0.44	V	$V_{IN} = V_{IL}$ or $V_{IH}$ (Note 3) $I_{OL} = 12$ mA
$I_{IN}$	Maximum Input Leakage Current	3.6		$\pm 0.1$	$\pm 1.0$	$\mu A$	$V_I = V_{CC}, GND$
$I_{OLD}$	Minimum Dynamic (Note 4) Output Current	3.6			36	mA	$V_{OLD} = 0.8V$ Max (Note 5)
$I_{OHD}$		3.6			-25	mA	$V_{OHD} = 2.0V$ Min (Note 5)
$I_{CC}$	Maximum Quiescent Supply Current	3.6		4.0	40.0	$\mu A$	$V_{IN} = V_{CC}$ or $GND$
$I_{OZ}$	Maximum 3-STATE Leakage Current	3.6		$\pm 0.25$	$\pm 2.5$	$\mu A$	$V_I (\overline{OE}) = V_{IL}, V_{IH}$ $V_I = V_{CC}, GND$ $V_O = V_{CC}, GND$
$V_{OLP}$	Quiet Output Maximum Dynamic $V_{OL}$	3.3	0.4	0.8		V	(Notes 6, 7)
$V_{OLV}$	Quiet Output Minimum Dynamic $V_{OL}$	3.3	-0.4	-0.8		V	(Notes 6, 7)
$V_{IHD}$	Minimum High Level Dynamic Input Voltage	3.3	1.7	2.0		V	(Notes 6, 8)
$V_{ILD}$	Maximum Low Level Dynamic Input Voltage	3.3	1.7	0.8		V	(Notes 6, 8)

**Note 3:** All outputs loaded thresholds on input associated with output under test.

**Note 4:** Maximum test duration 2.0 ms, one output loaded at a time.

**Note 5:** Incident wave switching on transmission lines with impedances as low as 75 $\Omega$  for commercial temperature range is guaranteed for 74LVQ.

**Note 6:** Worst case package.

**Note 7:** Max number of outputs defined as (n). Data inputs are driven 0V to 3.3V; one output at GND.

**Note 8:** Max number of Data Inputs (n) switching. (n - 1) inputs switching 0V to 3.3V. Input-under-test switching: 3.3V to threshold ( $V_{ILD}$ ), 0V to threshold ( $V_{IHD}$ ), f = 1 MHz.

## AC Electrical Characteristics

Symbol	Parameter	V <sub>CC</sub> (V)	T <sub>A</sub> = +25°C C <sub>L</sub> = 50 pF			T <sub>A</sub> = -40°C to +85°C C <sub>L</sub> = 50 pF		Units
			Min	Typ	Max	Min	Max	
t <sub>PHL</sub>	Propagation Delay	2.7	2.0	8.4	12.7	2.0	14.0	ns
t <sub>PLH</sub>	Data to Output	3.3 ±0.3	2.0	7.0	9.0	2.0	9.5	
t <sub>PZL</sub>	Output Enable Time	2.7	2.5	9.6	16.9	2.5	18.0	ns
t <sub>PZH</sub>		3.3 ±0.3	2.5	8.0	12.0	2.5	12.5	
t <sub>PHZ</sub>	Output Disable Time	2.7	1.0	10.8	19.0	1.0	20.0	ns
t <sub>PLZ</sub>		3.3 ±0.3	1.0	9.0	13.5	1.0	14.0	
t <sub>OSHL</sub>	Output to Output	2.7		1.0	1.5		1.5	ns
t <sub>OSLH</sub>	Skew Data to Output (Note 9)	3.3 ±0.3		1.0	1.5		1.5	

**Note 9:** Skew is defined as the absolute value of the difference between the actual propagation delay for any two separate outputs of the same device. The specification applies to any outputs switching in the same direction, either HIGH to LOW (t<sub>OSHL</sub>) or LOW to HIGH (t<sub>OSLH</sub>). Parameter guaranteed by design.

## Capacitance

Symbol	Parameter	Typ	Units	Conditions
C <sub>IN</sub>	Input Capacitance	4.5	pF	V <sub>CC</sub> = Open
C <sub>PD</sub> (Note 10)	Power Dissipation Capacitance	70	pF	V <sub>CC</sub> = 3.3V

**Note 10:** C<sub>PD</sub> is measured at 10 MHz.

**Physical Dimensions** inches (millimeters) unless otherwise noted

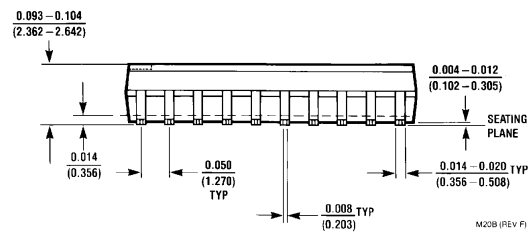
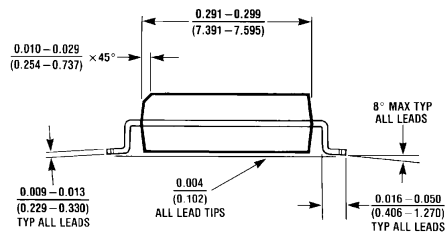
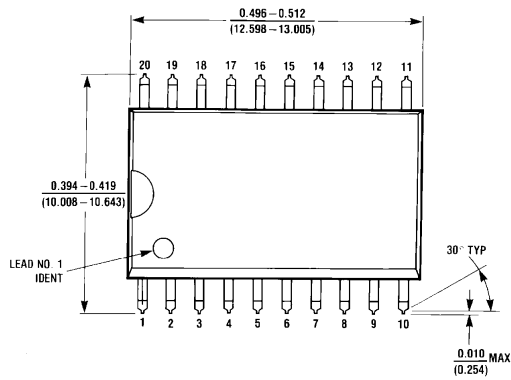

**20-Lead (0.300" Wide) Molded Small Outline Package, SOIC, JEDEC  
Package Number M20B**

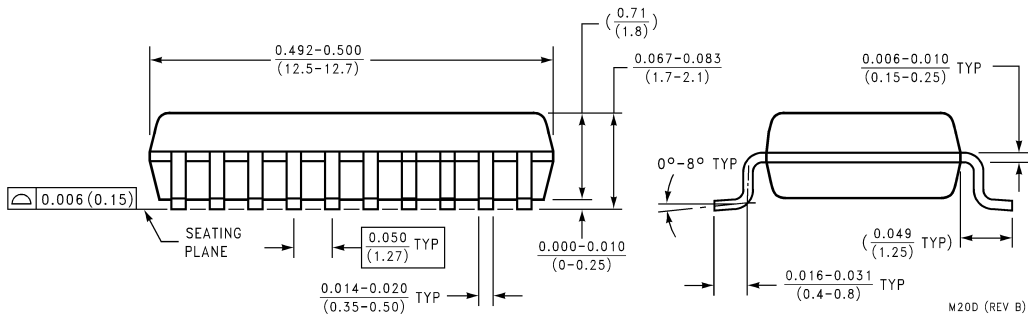
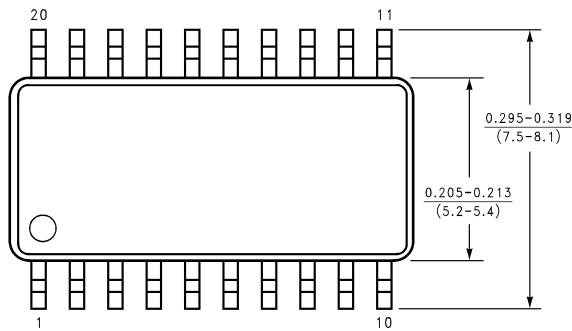

**20-Lead Shrink Molded Small Outline Package, SOIC, EIAJ  
Package Number M20D**

**Physical Dimensions** inches (millimeters) unless otherwise noted (Continued)

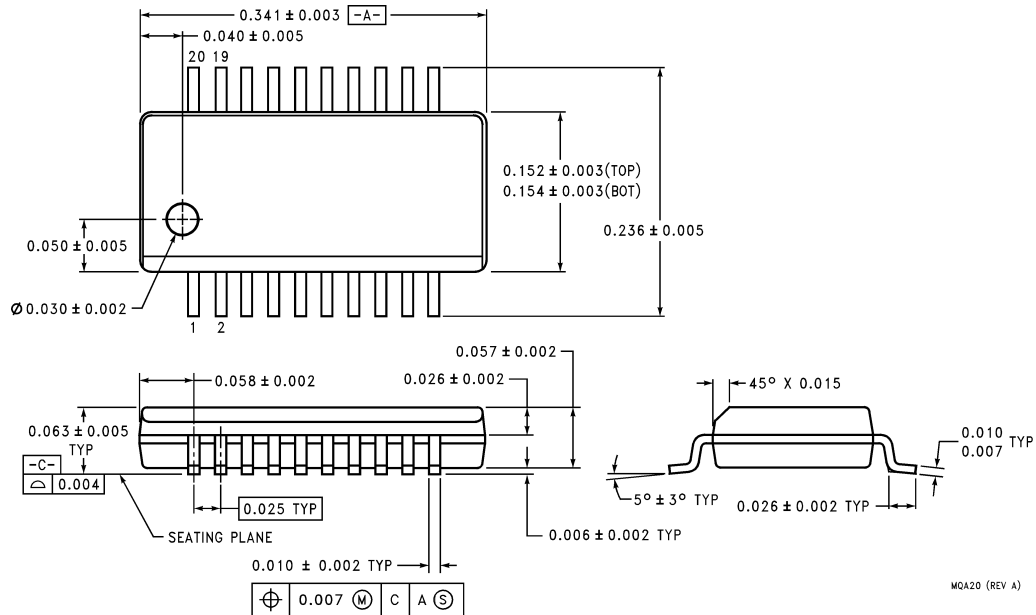

**20-Lead (0.150" Wide) Molded Shrink Small Outline Package, SSOP, JEDEC  
(also known as QSOP)  
Package Number MQA20**

MQA20 (REV A)

**LIFE SUPPORT POLICY**

FAIRCHILD'S PRODUCTS ARE NOT AUTHORIZED FOR USE AS CRITICAL COMPONENTS IN LIFE SUPPORT DEVICES OR SYSTEMS WITHOUT THE EXPRESS WRITTEN APPROVAL OF THE PRESIDENT OF FAIRCHILD SEMICONDUCTOR CORPORATION. As used herein:

1. Life support devices or systems are devices or systems which, (a) are intended for surgical implant into the body, or (b) support or sustain life, and (c) whose failure to perform when properly used in accordance with instructions for use provided in the labeling, can be reasonably expected to result in a significant injury to the user.
2. A critical component in any component of a life support device or system whose failure to perform can be reasonably expected to cause the failure of the life support device or system, or to affect its safety or effectiveness.

**Fairchild Semiconductor Corporation Americas**  
Customer Response Center  
Tel: 1-888-522-5372  
Fax: 972-910-8036

**Fairchild Semiconductor Europe**  
Fax: +49 (0) 1 80-530 85 86  
Email: europe.support@nsc.com  
Deutsch Tel: +49 (0) 8 141-35-0  
English Tel: +44 (0) 1 793-85-68-56  
Italy Tel: +39 (0) 2 57 5631

**Fairchild Semiconductor Hong Kong Ltd.**  
8/F Room 808 Empire Centre  
68 Mody Road, Tsimshatsui East  
Kowloon, Hong Kong  
Tel: 852-2722-8338  
Fax: 852-2722-8383

**Fairchild Semiconductor Japan Ltd.**  
4F, Natsume Bldg,  
2-18-6 Yushima, Bunkyo-ku,  
Tokyo 113-0034, Japan  
Tel: 81-3-3818-8840  
Fax: 81-3-3818-8450

www.fairchildsemi.com